

RATINGS AND CHARACTERISTICS CURVES (TA = 25 °C unless otherwise noted)

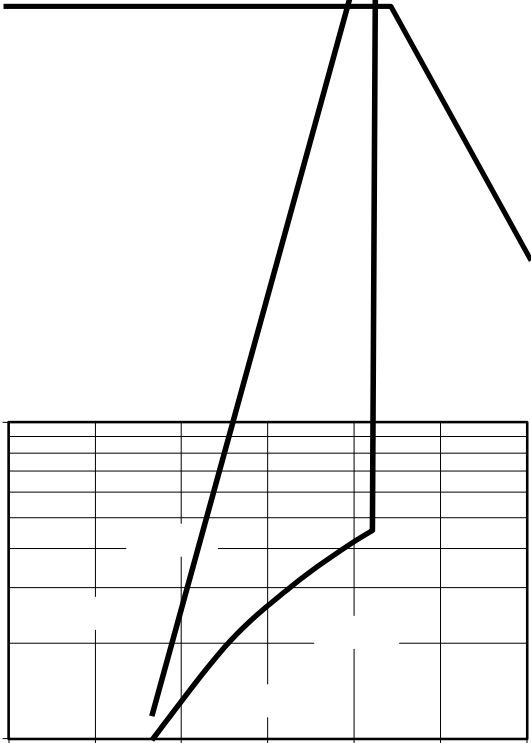



PACKAGE OUTLINE DIMENSIONS

SMAF

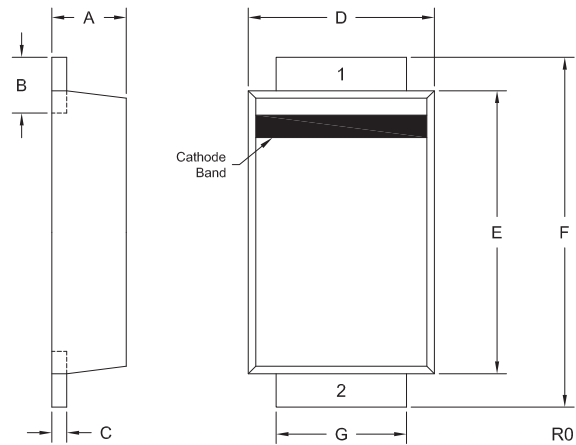

SMAF mechanical data

UNIT		A	B	C	D	E	F	G
mm	max	1.10	0.95	0.25	2.8	3.9	4.9	1.65
	min	0.85	0.50	0.11	2.2	3.2	4.2	1.20
mil	max	43.30	37.40	9.84	110.24	153.54	192.91	64.96
	min	33.46	19.68	4.33	86.61	125.98	165.35	47.24

SMAF Suggested Pad Layout

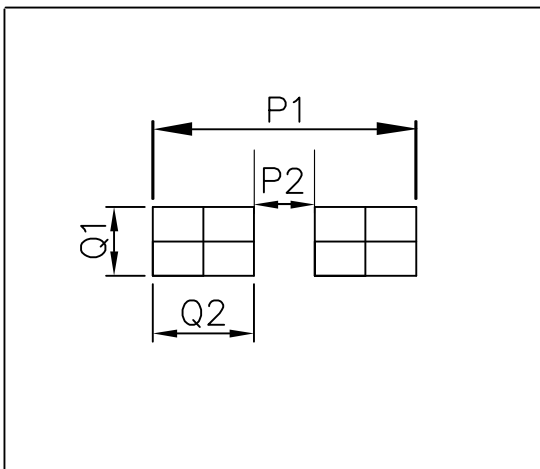

UNIT		P1	P2	Q1	Q2
mm	min	5.10	1.50	1.7	1.8
mil	min	200.8	59.05	67.0	70.87



Marking Information

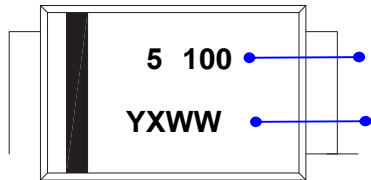

Product model : TSP5V100AF is abbreviated to 5 100
PDC information

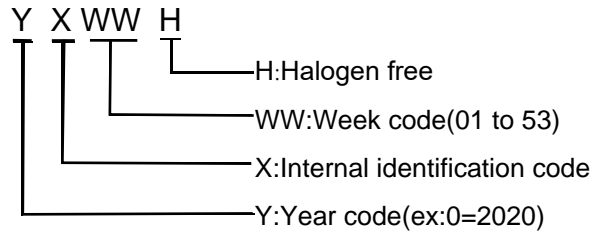

Packaging Information

1.Reel Dimensions

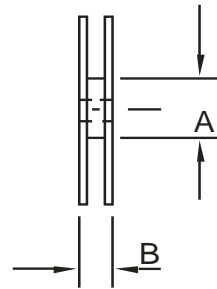
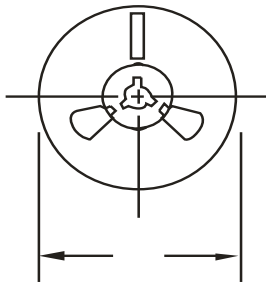

2. Inside Box

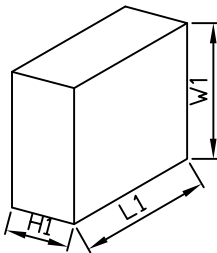

3. Outside Box

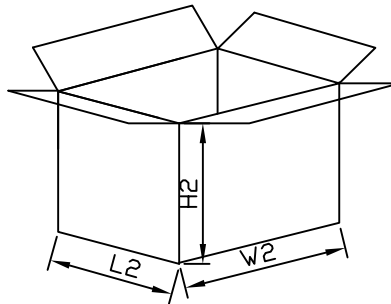

Packaging Information

NO	UNIT	Reel Dimensions			Inside Box			Outside Box		
		φ	A	B	L1	W1	H1	L2	W2	H2
Size	mm	178	55	11	180	183	120	270	375	235
QTY	PCS	Smallest package,3000PCS/reel			30,000PCS,10reel in total			120,000PCS/carton,4boxes in total		
Note	Tolerance 20mm,±3mm; 21-100mm,±5mm; 101-500mm,±10mm									