

7UHQFK 026 %DUULHU 6FKRWWN\ 5H

763 6 63

72

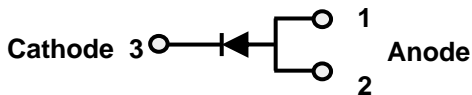

**Features**

- ‡ \$GYDQWUHQFK WHFKQRORJ\
- ‡ /RZRUZDURGDWDJH GURS
- ‡ /RZRZURVVHV
- ‡ +LJHILFLHQF\ RSHUDWLRO
- ‡ /HDGHHLQLVK &RPSOLDQW

**Applications**

- ‡ ' & ' & RQYHUWHUV
- ‡ \$ & ' & \$GDSWRUV
- ‡ 6ZLWFKRZHXSSOLHV
- ‡ )UHHZKHHLRGRJ

**Maximum ratings and electrical characteristics (TJ = 25°C unless otherwise noted)**

3DUDPHWHU		6\PERO	/LPLW	8QLW
0D[LPHSHVSHUNYHYURQHW DJH		9550		9
0D[LPHYHURJHZDUG UFXEWHIQWG		,) \$9		\$
3HDN IRVZDURUHQW VLQRDQZDYH VXSHULPSURVHURSHGLRGH		,) 60	0	\$
2SHUDMXQRDURQRWRUDJH WDESHUDW XUH767*			WR	f &
7\SLFDO WKHUPDO UHVLVWDQFH SHU		GLSRGH ORXQWHG RQ )5		3&f% :
,QVWDQWDQHRURWRUJZDUG SHGLRGH	,) \$	7- f &	7 < 3	0\$;
	,) \$	7- f &		
	,) \$	7- f &	,QVWDQWDQHRXV UHYHUVH	9
	,) \$	7- f &		

1RWHV

3XOVH WHVSHXOVH ZLGWK GXW\F\FOH

3XOVH WHVW 3XOPH ZLGWK 0

---

**RATINGS AND CHARACTERISTICS CURVES (TA = 25 °C unless otherwise noted)**

**PACKAGE OUTLINE DIMENSIONS**

7 2

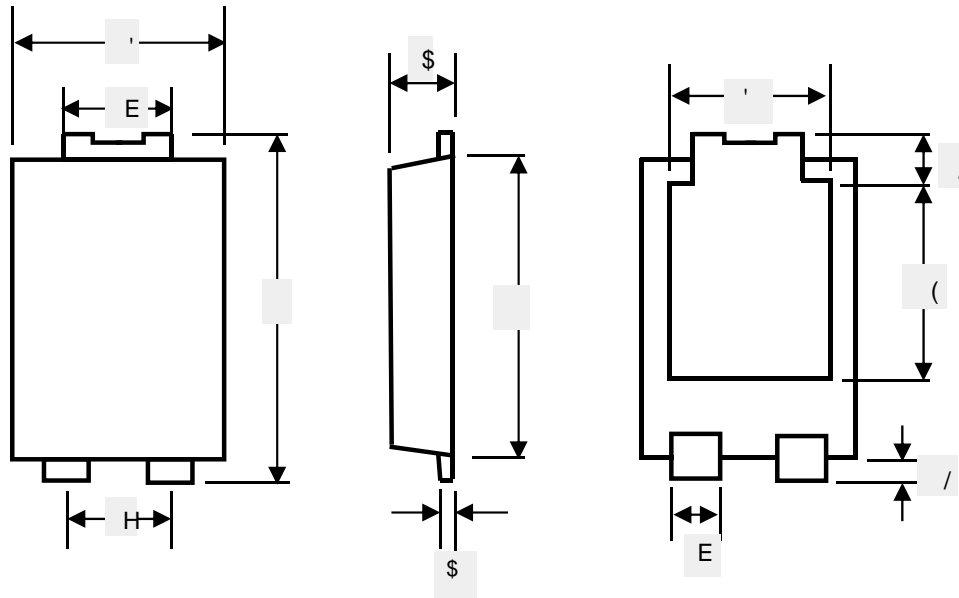

**TO-277 mechanical data**

8 1 , 7		\$	\$	E	E	'	'	(	(	(	/	/
P P	P D [											
	P L Q											
P L O	P D [											
	P L Q											

**7 2 Suggested Pad Layout**

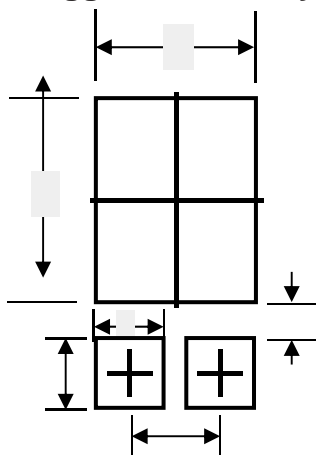

8 1 , 7		&	*	;	;		
P P	P L Q						
P L O	P L Q						

**Marking Information**

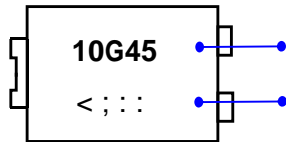

3URGXFW PRGHO 76310U45SPG  
WR DU4510  
3' & LQIRUPDWLRQ

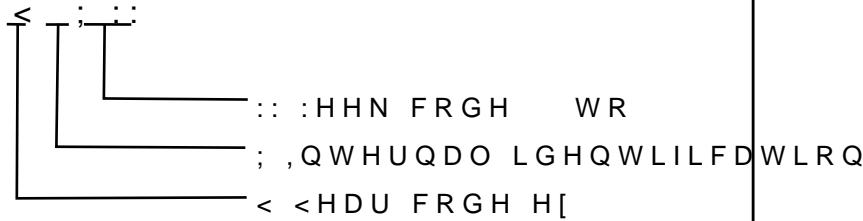

**Packaging Information**

5HHO 'LPHQVLRQV

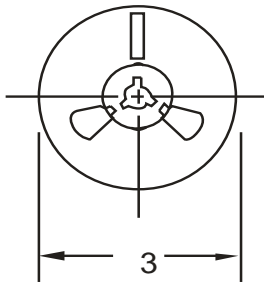

,QVLGH %R[

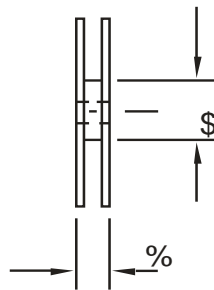

2XWVLGH %R[

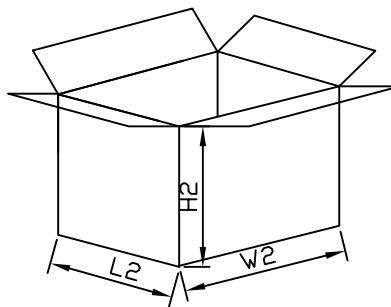
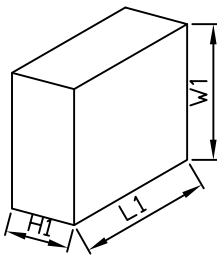

**Packaging Information**

12	81,7	5HHO'PHQVLRQV			,QVLGH %R[			2XWVLGH %R[		
6L]H	PP		\$	%	/	:	+	/	:	+
47<	3&6	6PDOOHVW SDFNDJH			3&6 UHHO			3&6 UHHO		
1RWH		7ROHUDQFH PP" PP			PP" PP			PP" PP		