

7 UHQFK 026 %DUULHU 6FKRWWN\ 5H

763 / 63

TO-277

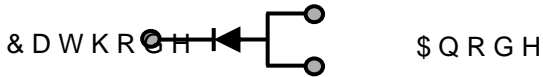

)HDWXUHV

‡ \$GYDQWUHQFK WHFKQRORJ\

‡ /RZRUZDURGDWDJH GURS

‡ /RZRZURVVHV

‡ +LJHILFLHQF\ RSHUDWLRO

‡ /HDGHLQLVK &RPSOLDQW

\$SSOLFDFWLRQV

‡ '&' &RQYHUWHUV

‡ \$&' &GDSWRUV

‡ 6ZLWFKRZLSSOLHV

‡ )UHHZKHHLRGLJ

0D[LPXP UDWLQJV DQG HOHFWULFDJ&FXODDWHVHURVWHIGFV

3DUDPHWHU		6\PERO	/LPLW	8QLW
0D[LPXPHSHVSHUNYHYURQWDJH		9550		9
0D[LPXPYHURJHZDUG UFXEWHIQWG		,) \$9		\$
3HDN IRUZDURSUHQW VLQRDWHQZDYH VXSHULPSURDWHVSHGLRGH		,) 60		\$
2SHUDMXQRDURQWRUDJH WDRSHUDW		XUH 767	WR	
7\SLFDO WKHUPDO UHVLVWDQFH SHU		GLSRGH	ORXQWHG RQ )5	3&f% :
,QVWDQWDQHRROWRUJZDUG SHGLRGH	,) \$	7- f&	7 < 3	0\$;
	,) \$	7- f&		
	,) \$	7- f&		9
	,) \$	7- f&		
,QVWDQWDQHRXUJSHURDWH UDWHYHYURQWDJH		7- f&		X\$
		7- f&	,5	P\$

1RWHV

3XOVH WHVVSXOVH ZLGWK GXW\F\FOH

3XOVH WHVW 3XOPH ZLGWK 0

5\$7,1\*6 \$1' &+\$5\$&7(5,67,&6 &7859(6f& XQOHVQRWKBUZLVH

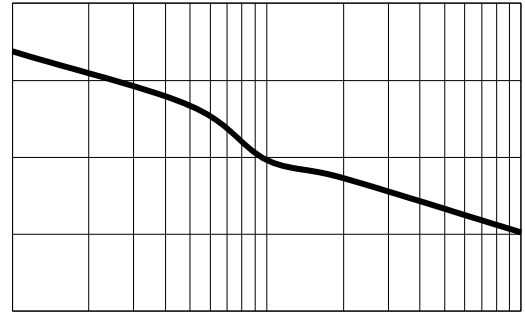
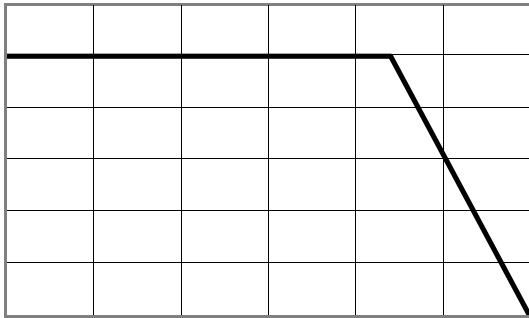

1

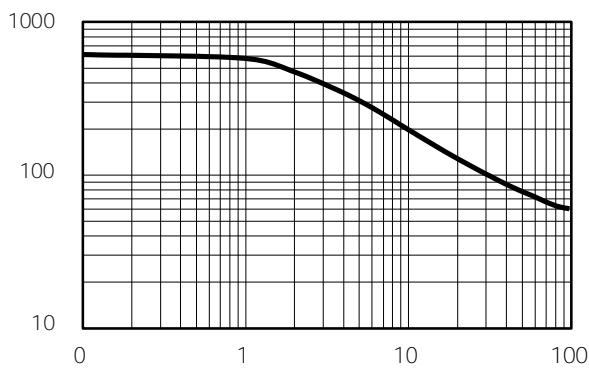
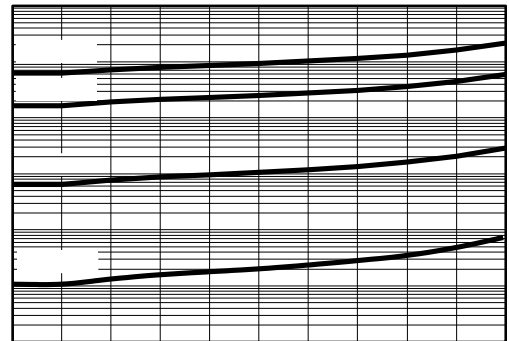
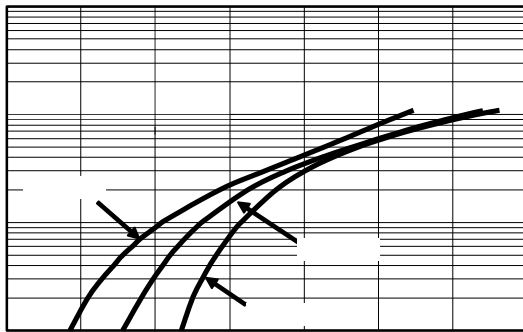

5HMH R0WJH9

3 \$ & . \$ \* ( 287 / , 1 ( ' , 0 ( 16 , 2 1 6

72

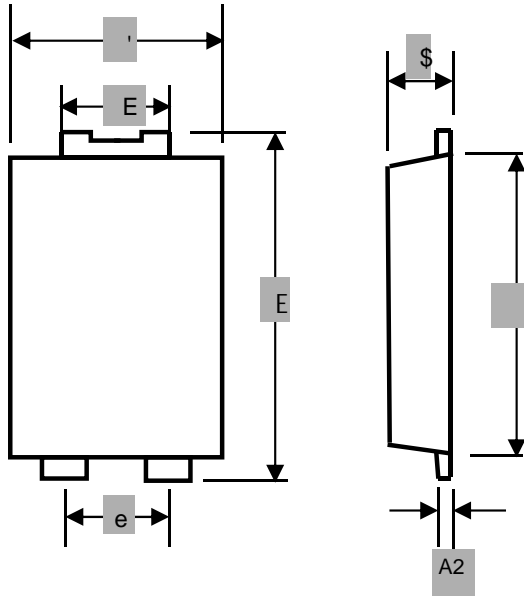

0DUNLQJ ,QIRUPDWLRQ

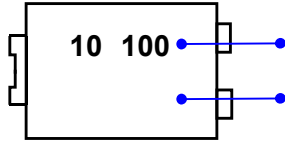

3URGXFW PRGHO 763 / 63 5HIHUL  
WR DV \$  
3' & LQIRUPDWLRQ

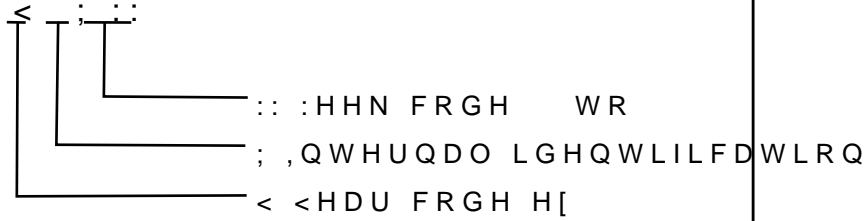

3DFNDJLQJ ,QIRUPDWLRQ

5HHO 'LPHQVLRQV

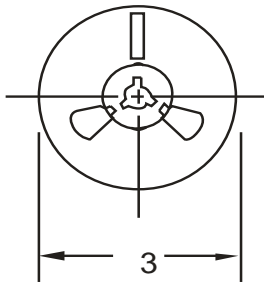

,QVLGH %R[

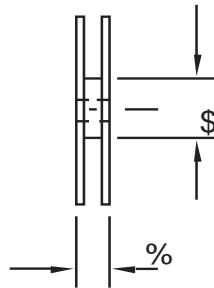

2XWVLGH %R[

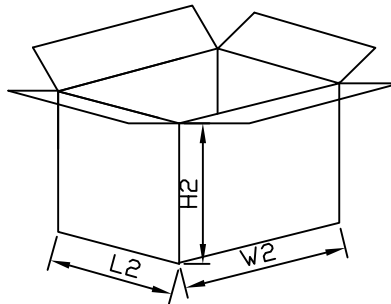
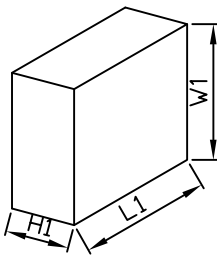

3DFNDJLQJ ,QIRUPDWLRQ

12	81,	5HHO 'LPHQVLR	,QVLGH %R[	2XWVLGH %R[
6L]H	PP			