

7UHQFK 026 %DUULHU 6FKRWWN\ 5H

763 / 63
TO-277

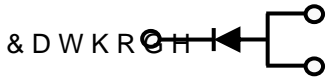

\$QRGH

)HDWXUHV

‡ \$GYDQWUHQFK WHFKQRORJ\

‡ /RZRUZVROWDJH GURS

‡ /RZRZURVVHV

‡ +LJHILFLHQF\ RSHUDWLRQ

‡ /HDGH)HLQLVK &RPSOLDQW

\$SSOLFDFWLRQV

‡ '& '& &RQYHUWHUV

‡ \$\$ '&\$GDSWRUV

‡ 6ZLWFKRZHSXSSOLHV

‡)UHHZKHHLRQJ

0D[LPXP UDWLQJV DQG HOHFWULFDJ& FXODDWHVHUQRWHIGFV

3DUDPHWHU		6\PERO	/LPLW	8QLW
0D[LPXPHSHVSHUNYHYURQWDJH		9550		9
0D[LPXPYHURJHZDUG UFKJWHIQWG		,) \$9		\$
3HDN IRUZDUEBUUHQW VLQDQHQZDYH VXSHULP&QDWHGRS&GLRGH		,)60		\$
2SHUDMXQDQDQWRUDJH WDRSHUDW		XUH 767	WR	f&
7\SLFDO WKHUPDO UHVLVWDQFH SHU		GLR&H	ORXQWHG RQ)5	3&f% :
,QVWDQWDQHRROWRUJZDUG SHGLRGH	,) \$	7- f&	7<3	0\$;
	,) \$	7- f&		
	,) \$	7- f&		
	,) \$	7- f&		
,QVWDQWDQHRXUUSHQWROWH UDWHYHYURQWDJH	7- f&	,5		X\$
	7- f&			P\$

1RWHV

3XOVH WHV&XOVH ZLGWK GXW\ F\FOH

3XOVH WHVW 3XOPH ZLGWK 0

5 \$ 7, 1 * 6 \$ 1' & + \$ 5 \$ & 7 (5, 6 7, & 6 & 7 8 9 (6 f & X Q O H V Q R W K B U Z L V H

, I, \$ Y H U D R H U Z D R X C U U H \$ Q W

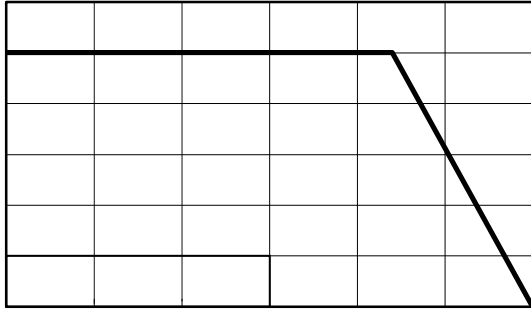

7 F & D V H 7 & H P S

Current Derating, Case

3 H D) R U Z D R X C U U H \$ Q W

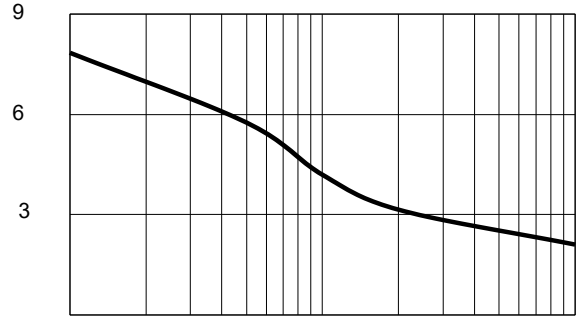

6

Maximum Repetitive Surge Current

, I, Q V W D Q W J R O U Z F R X C U U H \$ Q W

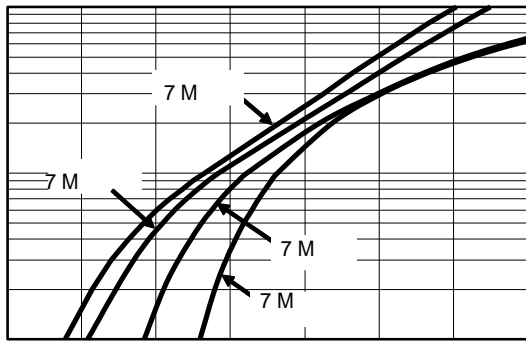

9 I , Q V W D Q W D Q H R X V) R U Z D U G 9 R O W D J H P 9

Typical Forward Voltage

, U 5 H Y H L & X H U U H X \$ W

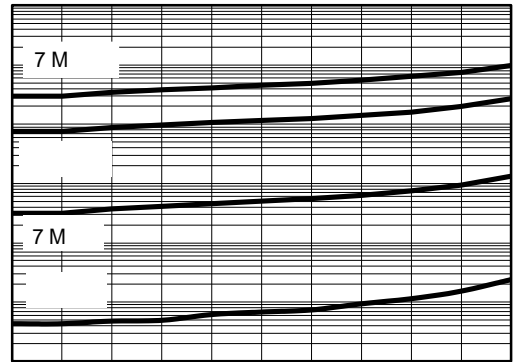

9 5 5 H Y H U V H 9 R O W D J H

Typical Reverse Current

& D S D F L W S D Q Q F H

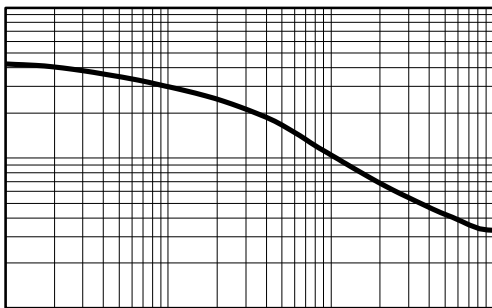

5 H Y H Q R Q H W Q J

Typical Junction Capacitance

3\$&.\$*(287/,1(',0(16,216

72

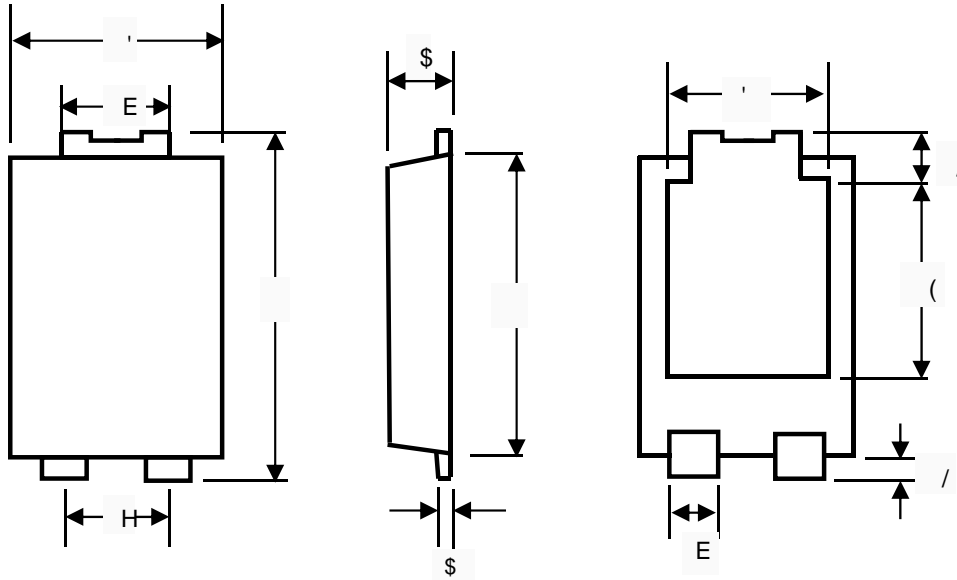

72 PHFKDQLFDO GDWD

81,7		\$	\$	E	E	'	'	(((/	/
PP	PD[
	PLQ											
PLO	PD[
	PLQ											

72 6XJJHVWDHGD\RXW

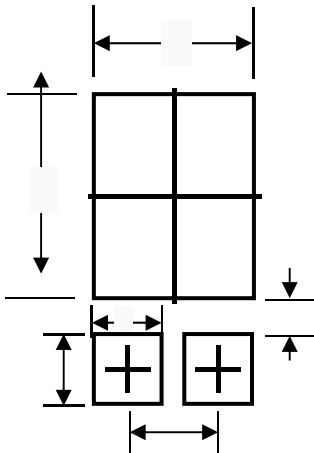

81,7		&	*	;	;		
PP	PLQ						
PLO	PLQ						

0DUNLQJ ,QIRUPDWLRQ

3URGXFW PRGHO 763 / 63 5H HUU
 WR DV /
 3' & LQIRUPDWLRQ

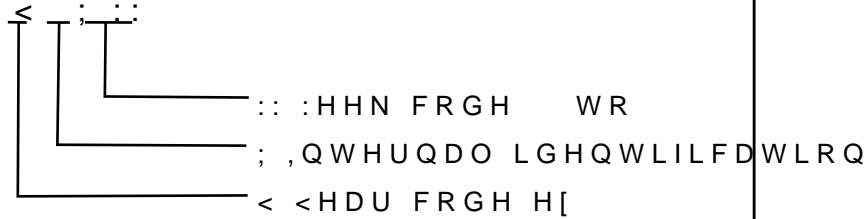
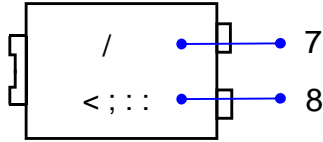

3DFNDJLQJ ,QIRUPDWLRQ

5HHO 'LPHQVLRQV

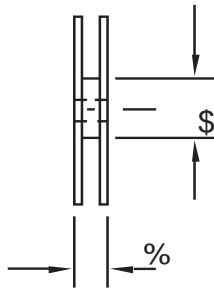
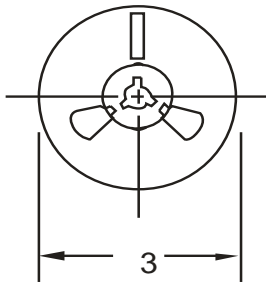

,QVLGH %R[

2XWVLGH %R[

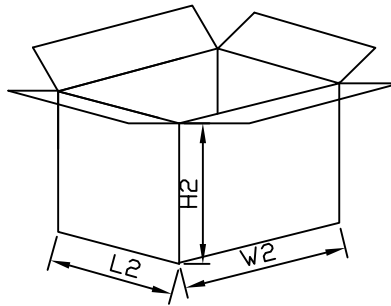
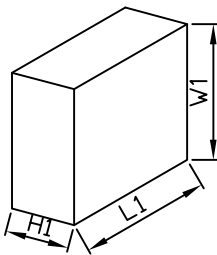

3DFNDJLQJ ,QIRUPDWLRQ

12	81,	5HHO 'LPHQVLRQV			,QVLGH %R[2XWVLGH %R[
		&	\$	%	/	:	+	/	:	+
6L]H	PP									
47<	3&6	6PDOOHVW SDFNDJH			3&6 UHHO			3&63&6HFFOERQWRWDO		
1RWH		7ROHUDQFH PP" PP			PP" PP			PP" PP		