

LHU 6FKRWWN\ 5H

WFHCGFK WHFKQRORJ\
ZDWDJH GURS
URVVHV
FLHQF\ RSHUDWLRQ
HLQLVK &RPSOLDQW

S
RQYHUWHUV
DSWRUV
KRQSSOLHV
KHHLGQJ

°C unless otherwise noted)

/LPLW	8QLW
	9
	\$

#b`d` € Pjp Ð a•H c

UHLIZDH ZDUTQCZD •c@ f4 ð•40

RATINGS AND CHARACTERISTICS CURVES (TA = 25 °C unless otherwise noted)

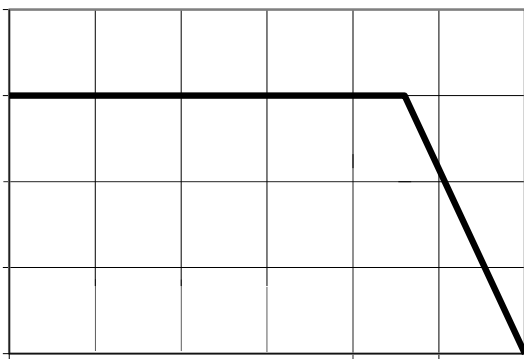

7₁ / HDG 7H8S

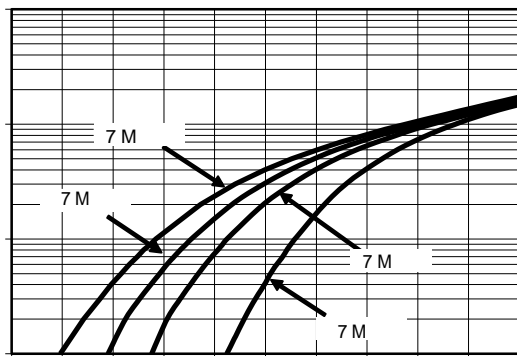
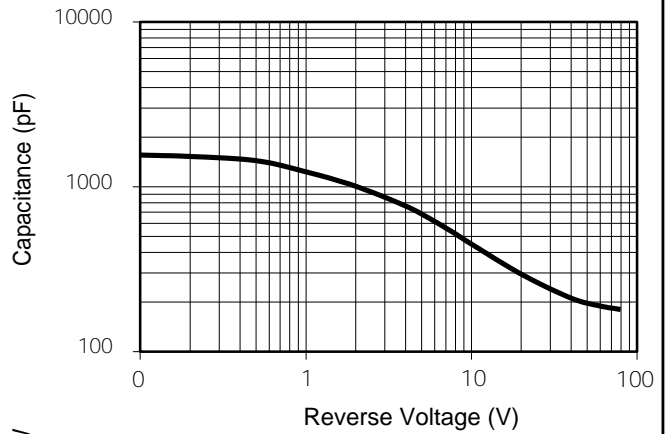

91 , QVWDQWDQHRXV)RUZDUG 9ROWDJH P9

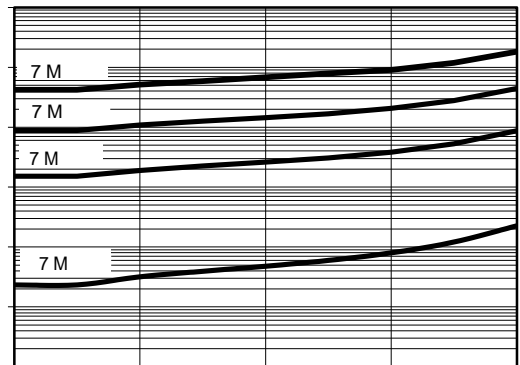

95 5HYHURVWDJH 9ROWV

PACKAGE OUTLINE DIMENSIONS

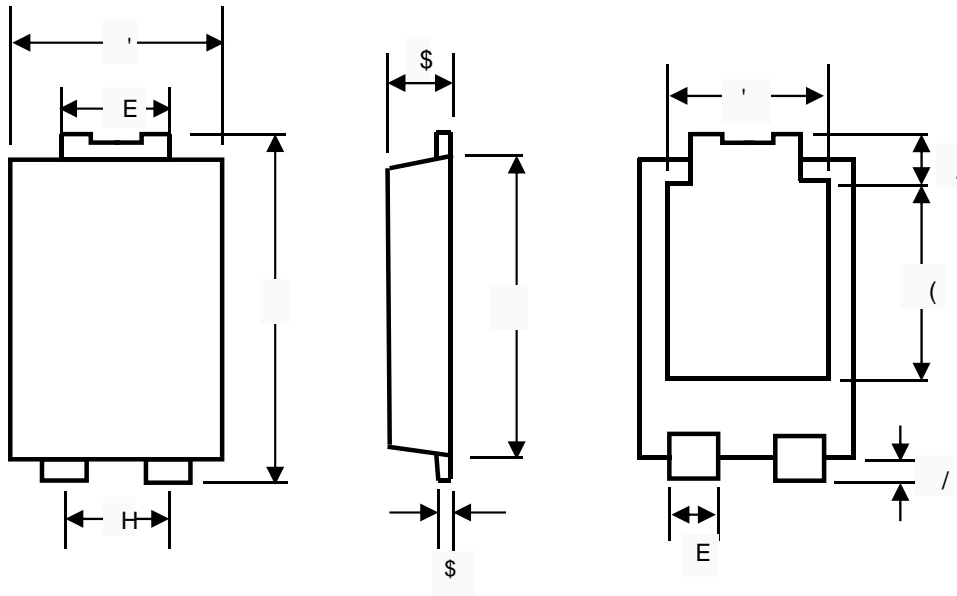

TO-277 mechanical data

81,7		\$	\$	E	E	'	'	(((/	/
PP	PD[
	PLQ											
PLO	PD[
	PLQ											

7.2 Suggested Pad Layout

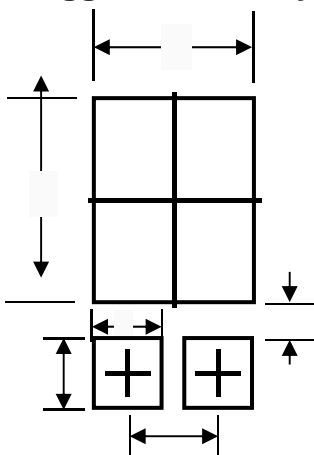

81,7		&	*	;	;		
PP	PLQ						
PLO	PLQ						

Marking Information

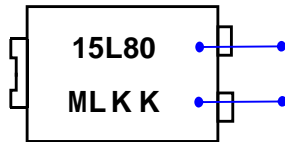

3 URGXFW PRGHO 7 6 3 1 5 L 8 0 S P G
WR DV 15L80

3 ' & L Q I R U P D W L R Q

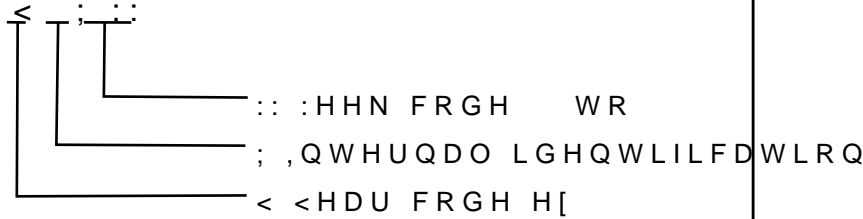

Packaging Information

5 H H O ' L P H Q V L R Q V

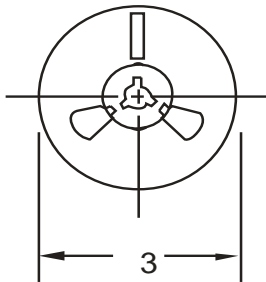

, Q V L G H % R [

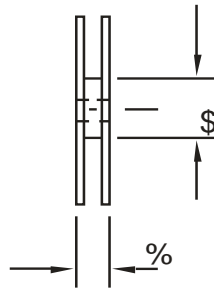

2 X W V L G H % R [

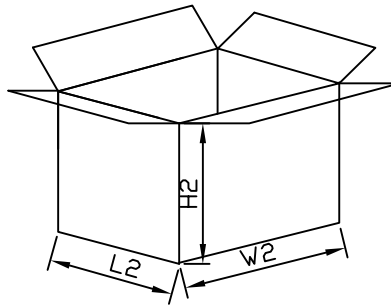
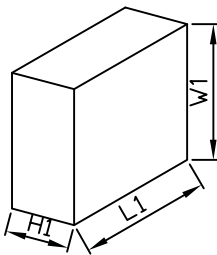

Packaging Information

12	8 1 , 7	5 H H O ' L P H Q V L R Q V	, Q V L G H % R [2 X W V L G H % R [
6 L] H	PP	\$	%	/	:	+	/	:	+
47 <	3 & 6	6 P D O O H V W S D F N D J H	3 & 6 U H H O	3 & 6 & 6 H F B O W R Q W R W D O W R W D					
1 R W H		7 R O H U D Q F H P " P P	PP " PP	PP " PP					