

RATINGS AND CHARACTERISTICS CURVES 7\$ ° & XQOHVV RWKHUZZLVH QRWHG



Capacitance (pF)

7 F & DVH 7&HPS

Reverse Voltage (V)

3 \$ & . \$ * (287 / , 1 (' , 0 (16 , 2 16

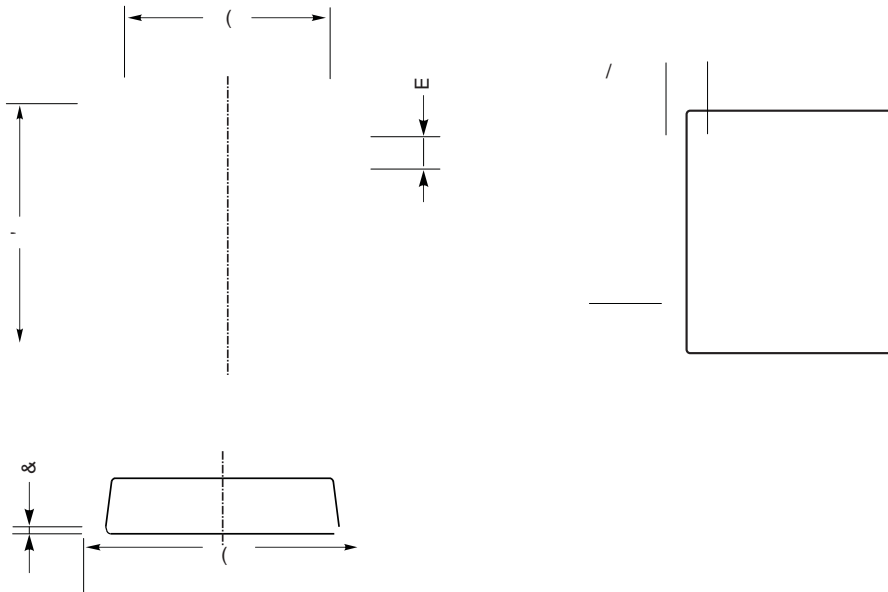

/ 6 % P H F K D Q G L F W D

| 8 1 , 7 | | \$ | & | ' | (| & | / | H | E |
|---------|-----|----|---|---|---|---|---|---|---|
| PP | PD[| | | | | | | | |
| | PLQ | | | | | | | | |
| PLO | PD[| | | | | | | | |
| | PLQ | | | | | | | | |

/ 6 % 6 X J J H V W H G 3 D G / D \ R X W

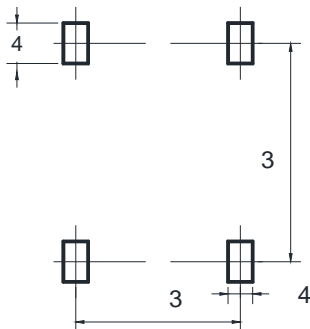

| 8 1 , 7 | | 3 | 3 | 4 | 4 |
|---------|-----|---|---|---|---|
| PP | PLQ | | | | |
| PLO | PLQ | | | | |

' L P H Q V I L R / Q R / L O O L P H W H U V



: 5 / 6 % 0

0DUNLQJ ,QIRUPDWLRQ

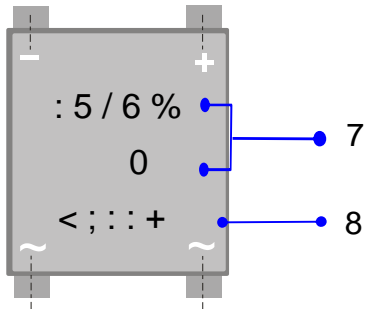

73URGXFW P5R 6% 00
83' & LQIRUPDWLRQ

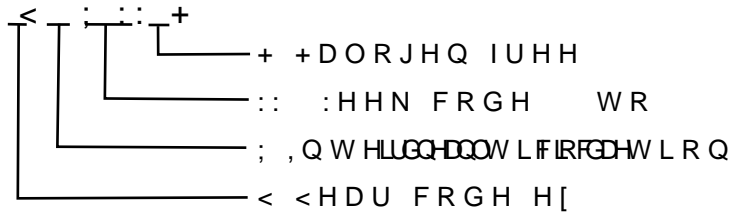

3DFNDJLQJ ,QIRUPDWLRQ

5HHO 'LPHQVLRQV

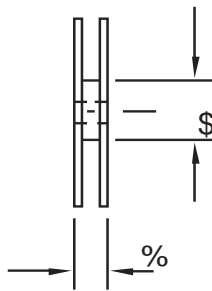
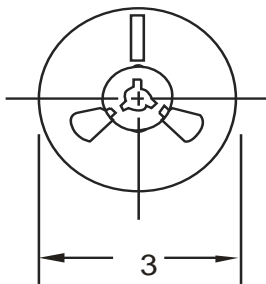

,QVLGH %R[

2XWVLGH %R[

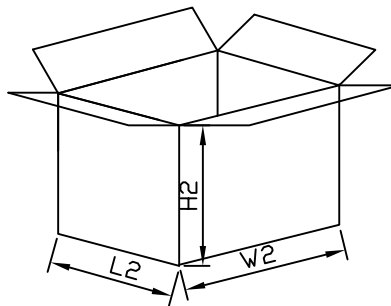
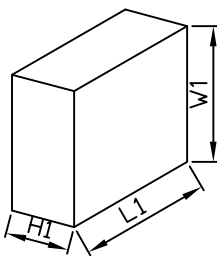

3DFNDJLQJ ,QIRUPDWLRQ

| 12 | 81, | 5HHO 'LPHQVLR | | | ,QVLGH %R[| | | 2XWVLGH %R[| | |
|------|-----|----------------------|----|---|---------------|---|---|-------------------|---|---|
| 6L]H | PP | & | \$ | % | / | : | + | / | : | + |
| 47< | 3&6 | 6PDOGSDVFDJH3&6 UHHO | | | 3&6 UHHO RWDO | | | 3&6 FDUERPRQ RWDO | | |
| 1RWH | | 7ROHUDQFPP" PP | | | PP" PP | | | PP" PP | | |