

6FKRWWN\ %ULGJH 5HFWLILHU

0D[LPX5PDWLQ0GOHFWEKDDOFWHLWLFV  
5DWLQWf &DPELMQHW SHUXDQXUMKHUZSLHFLYHG

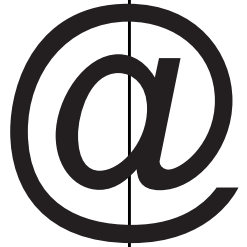

RATINGS AND CHARACTERISTICS CURVES

3HDN )RUZDUG 6XUDJH &XUUHQW \$QVWDQHRXV )RUZDUG &XUUHQW \$YHUDJH 5HFWLILHG 2XWSXW &XUUHQW

-XQFWLRQ &DSDFLWDQFH S ) ,QVWDQHRXV 5HYHUH \$XUUHQW (P

)LJ \$YHUDJH 5HFWLILHG 2XWSXW &XUUHQW )LJ 7\SLFDO 5HYHUH &KDUDFWHULVWLFV 'HUDWLQJ &XUYH

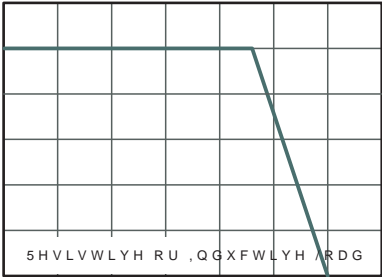

&DVH 7HPSHUDWXUH °&

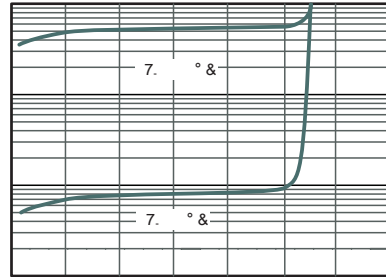

SHUFHQW R3IHDDW5HG YHUVH 9ROWDJH

)LJ 7\SLFDO ,QVWDQHRXV )RUZDUG &KDUDFWHULVWLFV

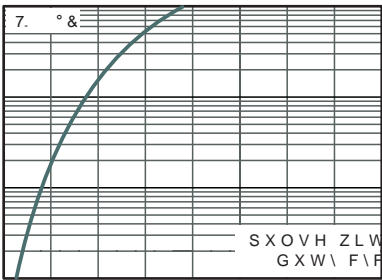

,QVWDQHRXV )RUZDUG 9ROWDJH 9

)LJ 7\SLFDO -XQFWLRQ &DSDFLWDQFH

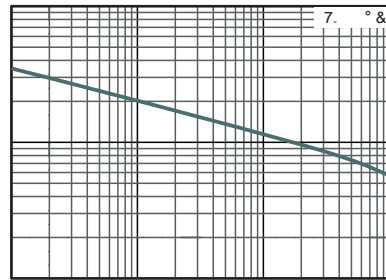

5HYHUH 9ROWDJH 9

)LJ 0D[LXP 1RQ 5SHHWLWLYH 3HDN )RUZDUG 6XUDJH &XUUHQW

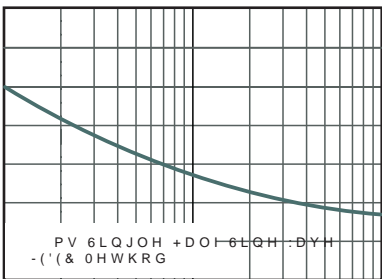

1XPEHU RI &\FOHV

L



5

@ N ° 3

06%PHFKDQGLFWO

81,7		\$	&	'	(	(	/	H	E	
PP	PD[									<i>f</i>
	PLQ									
PLO	PD[									
	PLQ									

06%6XJJHVWHG 3DG /D\RXW

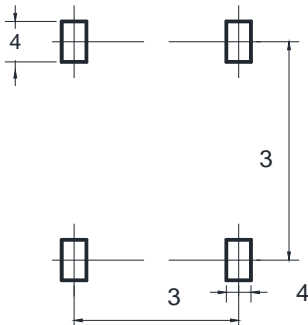

81,7		3	3	4	4
PP	PLQ				
PD	PLQ				

'LPHQVILR/QRLOOLPHWHUV

0DUNLQJ ,QIRUPDWLRQ

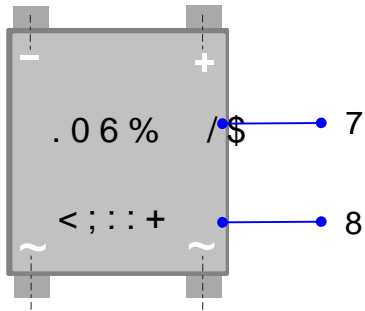

7 3URGXFW PRGHO .06% / \$  
8 3' & LQIRUPDWLRQ

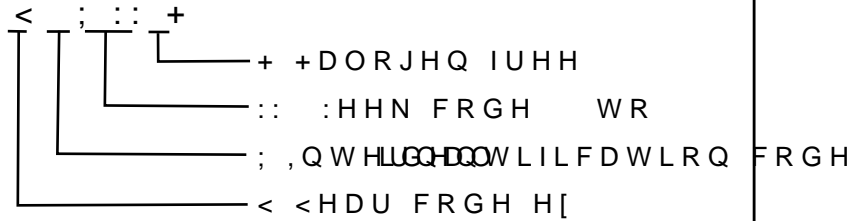

3DFNDJLQJ ,QIRUPDWLRQ

5HHO 'LPHQVLRQV

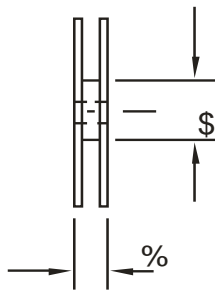
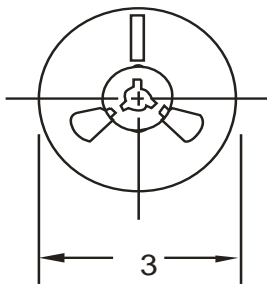

,QVLGH %R[

2XWVLGH %R[

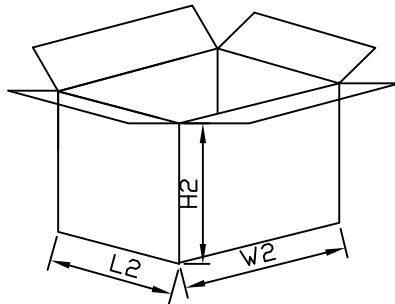
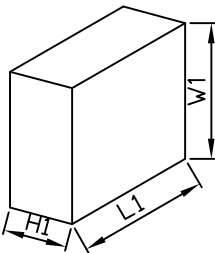

3DFNDJLQJ ,QIRUPDWLRQ

12	81,	5HHO 'LPHQVLR			,QVLGH %R[			2XWVLGH %R[		
		\$	\$	%	/	:	+	/	:	+
6L]H	PP									
47<	3&6	6PDOGDFW DJH 3&6 UHHO			3&6 UHHO RWDO			3&6 FDUERLQ RWDO		
1RWH		7ROHUDQFH PP" PP			PP" PP			PP" PP		